

Product data sheet

Characteristics

XUYPS1LCO965S

Photoelectric sensors XU, XUY, BGS, laser, Sn
300 mm, 12...24 VDC, M8



Product availability: Non-Stock - Not normally stocked in distribution facility

Price*: 708.00 USD



Main

Range of Product	Telemecanique Photoelectric sensors XU
Series name	Application, materials handling
Electronic sensor type	Photo-electric sensor
Sensor name	XUY
Sensor design	Compact
Detection system	Diffuse with background suppression
Material	Plastic
Type of output signal	Discrete
Supply circuit type	DC
Wiring Technique	4-wire
Discrete output type	PNP and NPN
Discrete output function	1 NO or 1 NC programmable
Electrical connection	1 male connector M8, 4 pins
Product Specific Application	Control of level Monitoring of small parts on production machine Monitoring for crack on a component Suppression of a background Detection of components on a printed circuit
Emission	Red laser, pulsed 0.000026575 in (675 nm) - class 2
[Sn] nominal sensing distance	1.97...11.81 In (50...300 mm)

Complementary

Enclosure Material	Glass impregnated nylon
Lens material	PMMA
Spot diameter	0 in (0 mm) manual adjustment
Minimum object diameter for detection	0.02 In (0.5 mm)
Output Type	Solid state
Status LED	Output state 1 LED green) NC function 1 LED none) NO function 1 LED red) Time delay active 1 LED red)

[Us] rated supply voltage	12...24 V DC with reverse polarity protection
Supply voltage limits	10...30 V DC
Switching capacity in mA	100 mA (overload and short-circuit protection)
Switching frequency	> 5 kHz
Maximum voltage drop	<2 V closed state)
Current consumption	35 mA
Maximum delay response	40 Ms output circuit depending on wiring
Maximum delay recovery	150 Ms
Setting-up	Manual adjustment of focusing
Net Weight	0.18 Lb(US) (0.081 kg)

Environment

Product Certifications	CULus CE
Ambient Air Temperature for Operation	32...122 °F (0...50 °C)
Ambient Air Temperature for Storage	-4...140 °F (-20...60 °C)
Immunity to ambient light	10000 Lux natural light 500 Lux incandescent bulb
IP degree of protection	IP65 conforming to IEC 60529



Ordering and shipping details

Category	22481 - SENSORS, PHOTOELECTRIC
Discount Schedule	DS2
GTIN	03389119007276
Nbr. of units in pkg.	1
Package weight(Lbs)	2.54 Oz (72 g)
Returnability	No
Country of origin	FR

Packing Units

Unit Type of Package 1	PCE
Package 1 Height	1.34 In (3.4 cm)
Package 1 width	5.04 In (12.8 cm)
Package 1 Length	2.91 In (7.4 cm)
Unit Type of Package 2	S02
Number of Units in Package 2	35
Package 2 Weight	6.33 Lb(US) (2.873 kg)
Package 2 Height	5.91 In (15 cm)
Package 2 width	11.81 In (30 cm)
Package 2 Length	15.75 In (40 cm)

Offer Sustainability

Sustainable offer status	Green Premium product
California proposition 65	WARNING: This product can expose you to chemicals including: Diisononyl phthalate (DINP), which is known to the State of California to cause cancer, and Diisodecyl phthalate (DIDP), which is known to the State of California to cause birth defects or other reproductive harm. For more information go to www.P65Warnings.ca.gov
REACH Regulation	 REACH Declaration
EU RoHS Directive	Pro-active compliance (Product out of EU RoHS legal scope)  EU RoHS Declaration
Mercury free	Yes
RoHS exemption information	 Yes

Environmental Disclosure	Product Environmental Profile
Circularity Profile	End Of Life Information

Contractual warranty

Warranty	18 months
----------	-----------

Dimensions

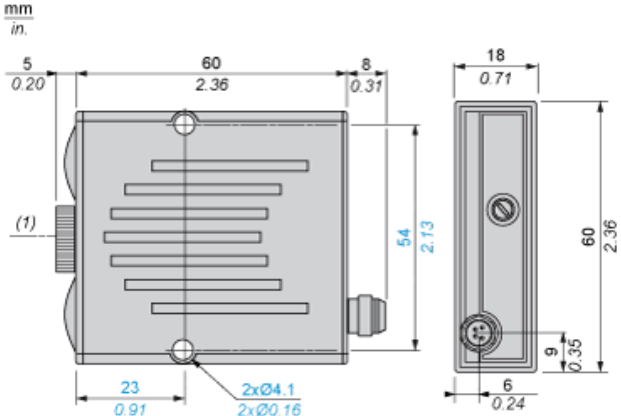

(1) Optical axis of laser

Wiring Schemes

M8 Connector

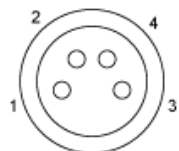

- 1 : Brown
- 2 : White
- 3 : Blue
- 4 : Black

NO Function

Without time delay

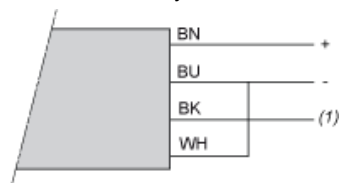

With 40 ms time delay

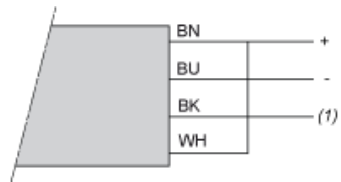

- BN : Brown
- WH : White
- BU : Blue
- BK : Black
- (1) Output

NC Function

Without time delay

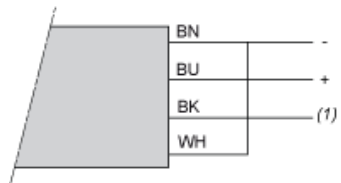

With 40 ms time delay

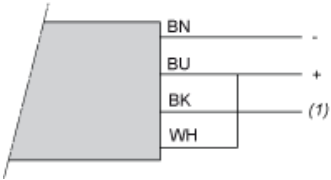

BN : Brown
WH : White
BU : Blue
BK : Black
(1) Output

Product Life Status : **Commercialised**